

Research in use of fuel conversion adapters in automobiles running on bioethanol and gasoline mixtures

V. Pirs* and M. Gailis

Motor Vehicle Institute, Faculty of Engineering, Latvia University of Agriculture, 5 Janis Cakste boulevard, LV-3001, Jelgava, Latvia;

*Correspondence: vilnis.pirs@llu

Abstract. By using fuel conversion adapters, bioethanol and gasoline mixture (E85) can be used in automobiles which are designed to work with fossil fuel. Such adapters increase the amount of the injected fuel, by adjusting the opening time of injectors. Different fuel conversion adapters are available in various automobile markets, for instance, European and North American.

The working principles and efficiency of usage of fuel conversion adapters are little researched and there is a lack of scientific studies in this area.

The aim of this research is to explore the working properties, efficiency of usage and influence on automobile operational parameters of two different fuel conversion adapters.

The authors found a significant difference in the design approach regarding availability of functions, working and regulation principles between different conversion adapters. The increase of the amount of the injected fuel is realised by prolonging of the original injector opening impulse or by generating an additional impulse. Both conversion adapters, subjected to tests, increased the amount of the injected fuel during cold start conditions. During full load conditions, full capacity of fuel injectors was reached and no further enrichment of air/fuel mixture was possible. The findings of the research can be useful for selection of a suitable fuel conversion adapter and providing guidance for designing of better adapters.

Key words: bioethanol, ethanol, spark ignition engine, conversion adapter.

INTRODUCTION

According to the directive 2009/28/EC of the European Parliament and of the Council, a target of 10% for energy from renewable sources in transport must be reached in year 2020 by all Member States (Directive 2009/28/EC). To reach this target in Latvia, the share of energy, obtained from renewable sources, must be increased. One of the possible solutions is to increase use of biofuels in transport, by adapting the current automotive fleet to use a fuel mix with a high amount of biofuel, for instance E85.

Most of the automobiles in use in Latvia, equipped with spark ignition (SI) engines, have multipoint indirect injection systems (Mistris & Birzietis, 2011). Several solutions exist to adapt such automobiles to use E85 fuel. Solutions differ according to the architecture, available functions and operational performance. Dedicated kits are offered in the USA and European markets, which are easy to install and basically provide enrichment of fuel/air mixture, allowing the use of E85 fuel instead of gasoline

(Whitelighting; Ecofuelbox). The conversion kit is connected to the engine control unit (ECU) and fuel injectors. In some cases data from additional or ECU sensors are used (Flexfuelus).

Despite the wide offer of conversion kits in the market, there is a lack of scientific research regarding the efficiency and influence of such conversion kits on the operational parameters of automobiles. While reviewing scientific publications in the field of application of bioethanol as a fuel, no publication was found concerning such fuel conversion kits, according to the knowledge of the authors.

The aim of the research is explore and evaluate working features, efficiency and influence on the operational parameters of automobiles from two different fuel conversion kits.

MATERIALS AND METHODS

Objects of research are two fuel conversion kits – *Etanizer*, which is offered for sale in Europe and *RMG Rapsol B5-STANDARD*, which is produced and marketed in Germany. The kits are shown in Fig. 1.

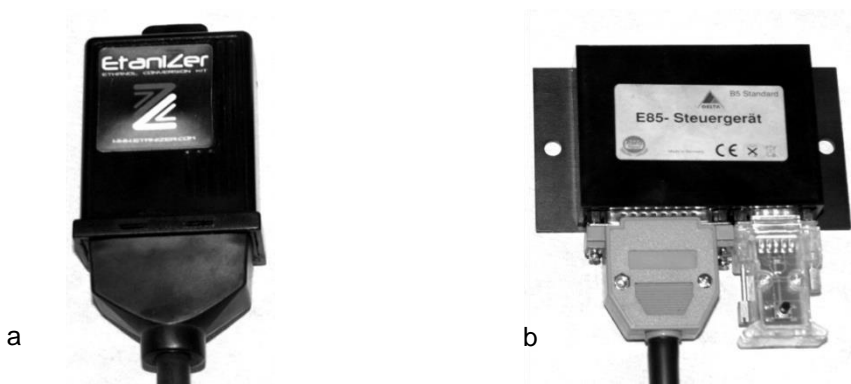

Figure 1. Conversion kits: a – *Etanizer*; b – *RMG Rapsol B-STANDARD*.

Main features of conversion kits are summarised in Table 1.

Table 1. Technical characteristics of the conversion kits

Model	Etanizer	RMG Rapsol B5 – STANDARD
Cold start function	present	present
Adjustment	manual using potentiometer	programmable, adaptive
Correction of injection time	present	present
Correction of ignition timing	absent	absent
Use of external sensors	absent	air/fuel ratio, coolant temperature, throttle position

Both conversion kits are electrically connected to the ECU and fuel injectors, interrupting existing connections, and connected to a chassis ground. RMG Rapsol B5 – STANDARD is connected to a vehicle’s original oxygen sensor, coolant temperature signal and throttle position sensor. Diagrams of connection are shown in Fig. 2.

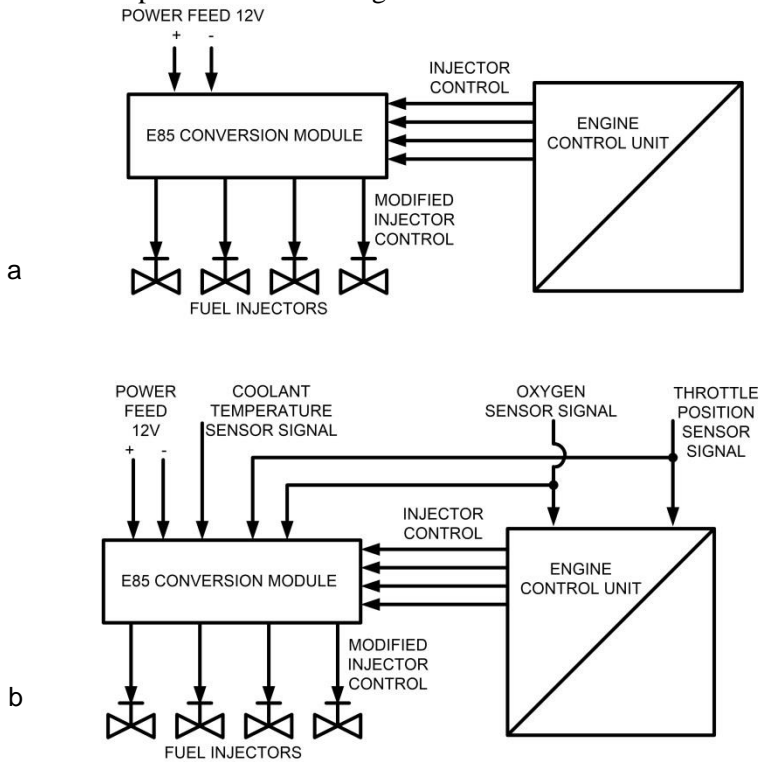

Figure 2. Diagrams of electrical connection: a – Etanizer; b – RMG Rapsol B5 –STANDARD.

Conversion kits were installed on a standard production automobile VW Passat, equipped with 1.8 l SI engine. Main technical characteristics of the test automobile are summarised in Table 2.

Table 2. Technical characteristic of the test automobile

Model	VW Passat
Production year	1997
Engine	4-cylinder 20-valve SI 1781 cc engine; VW type ADR
Compression ratio	10.3
Fuel & ignition system	Bosch Motronic M3.8.2
Engine power, kW (Hp)	92 (125)
Engine control	Closed-loop control
Gearbox	5-gear manual; final drive ratio 4.111; 4 th gear ratio 1.029

Measurements of fuel consumption were conducted on chassis dynamometer Mustang MD1750, using conditions of driving test cycle IM-240, which is developed and used in the United States of America for inspection and maintenance purposes.

Technical equipment and settings of chassis dynamometer allow the creation of test conditions close to real street use. In addition to the measurement of fuel consumption, tests of engine power and torque were conducted. Testing was performed using a specific test mode, with a wide open throttle and gearbox set in 4th gear.

Fuel consumption was performed using the high precision and accuracy fuel measurement system AVL KMA Mobile. Main technical data are presented in Table 3.

Table 3. AVL KMA Mobile technical characteristic

Parameter	Unit	Value
Measuring range	l h ⁻¹	0.35–150
Fuel density range	g cm ³	0.5–2
Measuring error	%	0.1

Tests were performed using gasoline A95 and bioethanol/gasoline mixture E85, supplied by Statoil.

To evaluate the performance of fuel conversion kits, injector control signals were studied, using automotive oscilloscope Picoscope 3423. Injector control signal voltage was measured before and after the conversion kit, using separate input channels of the oscilloscope.

Layout and connections of measurement systems is shown in Fig. 3.

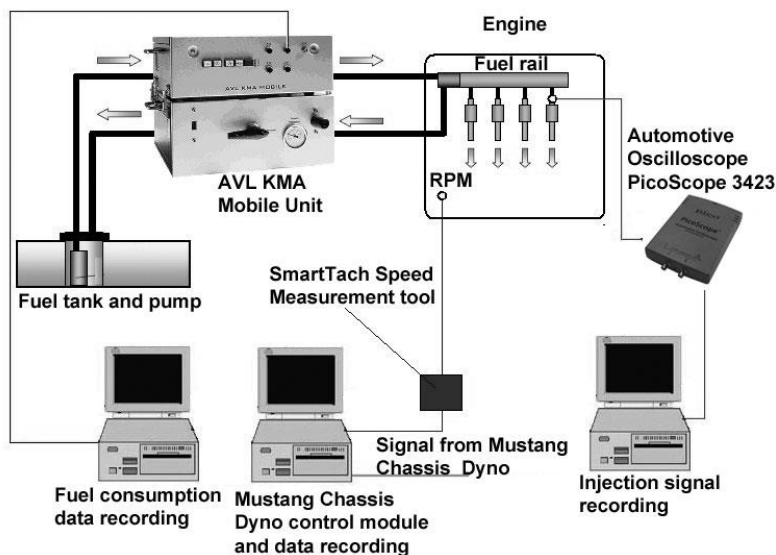

Figure 3. Principal connections of the measurement systems.

Measurements of the engine brake power and fuel consumption were performed with five repetitions. Mean value was used as a result of the test. Error bars, used in the graphs, show 95% confidence intervals.

Operational parameters of the automobile, in unmodified standard production setup, using gasoline, and with two different conversion kits using E85 fuel were compared and evaluated.

RESULTS AND DISCUSSION

According to the results of this research both conversion kits provide enrichment of air/fuel mixture during cold start and other running modes of the engine. Working principle of enrichment is different for each tested conversion kit. Conversion kit *Etanizer* provides enrichment of air/fuel mixture by generating an additional injector opening pulse, depending on duration of injector opening pulse, supplied by the ECU and position of the manual adjustment potentiometer. From the signal pattern, shown in Fig. 4, it can be noted, that conversion kit *Etanizer* does not interrupt any existing electrical connection between ECU and fuel injector. Additional injector control pulse, generated by *Etanizer*, is detectable also on the injector control connection of the ECU.

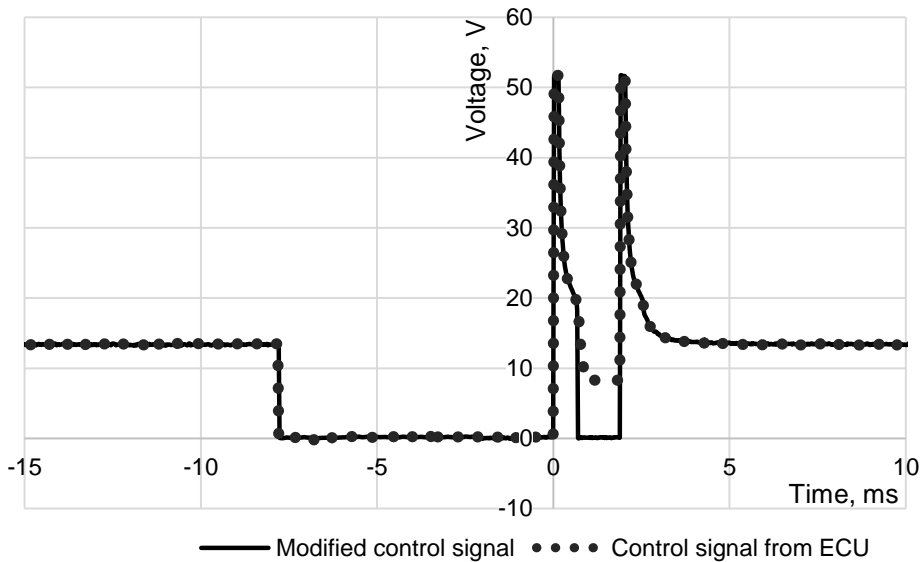

Figure 4. Injector control signal modification by *Etanizer*.

Conversion kit *RMG Rapsol B5-STANDARD* operates by replacing the original injector opening pulse, which is supplied by ECU, by a new, extended pulse. Control signal forms are shown in Fig. 5. Injector control circuit of the ECU is electrically isolated from the injector coil by conversion kit *RMG Rapsol B5-STANDARD*. That explains the square waveform of the pulse, generated by ECU, as no coil is being de-energised at the end of the pulse. In this case a new injector control pulse is calculated and generated by the conversion kit. Distinctive ways of injector control influence operation of the engine. Operation of the engine under load was unstable, when it was tested with conversion kit *Etanizer*. A possible explanation of the unstable operation can be an erratic injector control signal.

In Fig. 6 is shown a diagram of engine brake power. Variation of value of maximal power and the pattern of the curves, compared between tests using gasoline and E85 with both conversion kits are mostly within 95% confidence intervals.

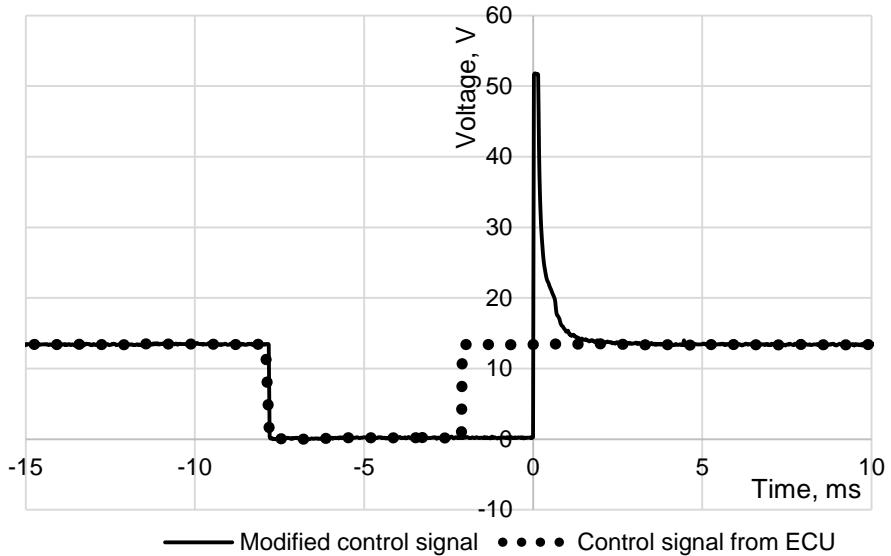

Figure 5. Injector control signal modification by *RMG Rapsol B5 STANDARD*.

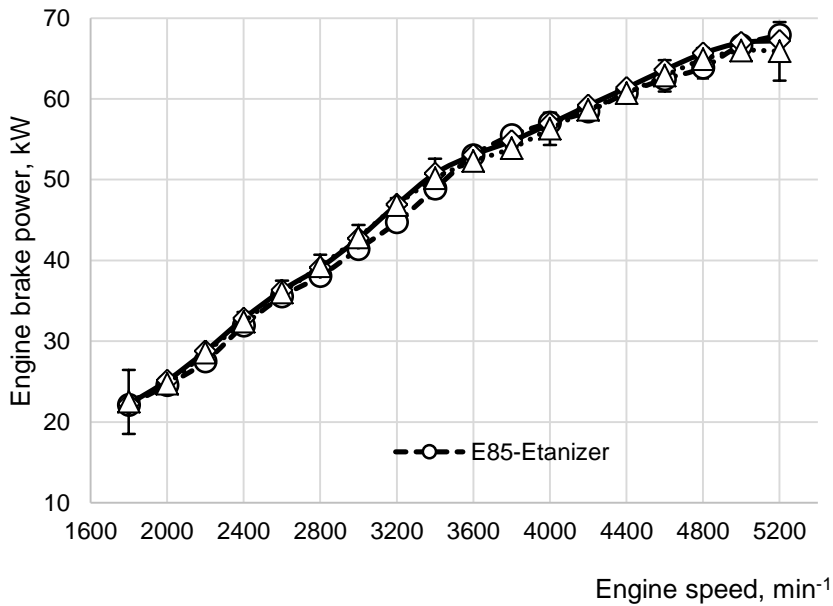

Figure 6. Fuel and conversion kit influence on engine brake power.

The most significant difference compared with an unmodified operation using A95 fuel, is present within the engine speed range from $\sim 2000 \text{ min}^{-1}$ to $\sim 3600 \text{ min}^{-1}$, where the engine reached lower power and torque, when it was operating with conversion kit *Etanizer* on E85 fuel. The effect is shown in Fig. 6 and Fig. 7.

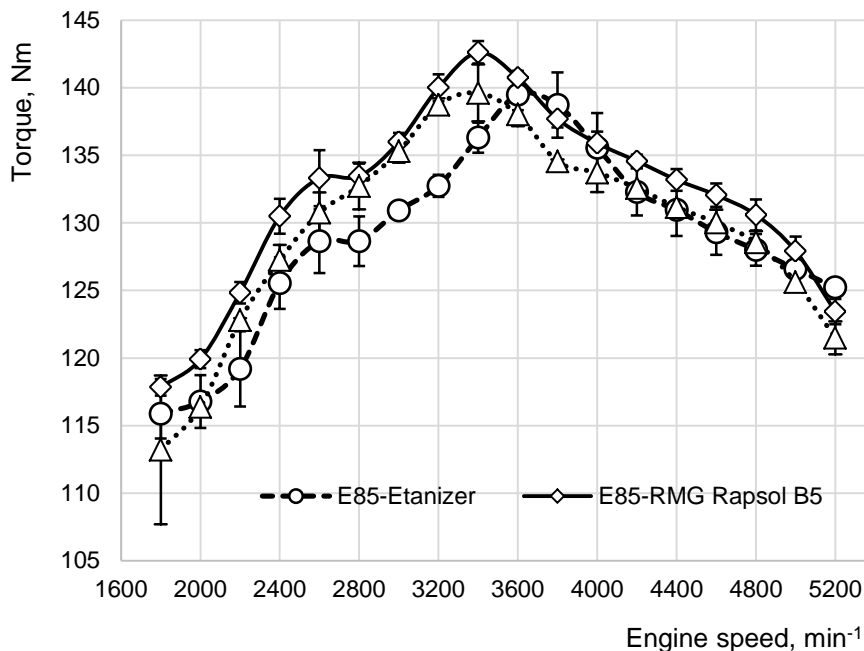

Figure 7. Fuel and conversion kit influence on engine torque.

From Fig. 9 it can be noted an increase of maximal torque by 2%, when operating an engine with the conversion kit *RMG Rapsol B5-STANDARD* on E85, compared with the operation of an unmodified engine on gasoline.

Use of conversion kit *Etanizer* does not change maximal torque value, however it is reached at higher engine speeds. Unstable engine operation with the conversion kit *Etanizer* increased variation within results of the tests.

According to Pourkhesalian et al. (2010), in a dual-fuel or flexible-fuel engine, some performance properties might be sacrificed.

Operation of the conversion kits can be illustrated by analysis of the air-fuel equivalence ratio during power test. Results are presented in Fig. 8. When an engine operates on gasoline, the air/fuel mixture is rich ($\lambda \sim 0.93\text{--}0.95$) at engine speeds above $2,500 \text{ min}^{-1}$. During full load conditions, while the throttle valve is completely open, ECU strategy is to work in open loop mode. During open loop mode, information from the oxygen sensor is not used and the air/fuel mixture is prepared using a preprogrammed algorithm. Achieved air/fuel mixture ratio ensures maximal power using gasoline.

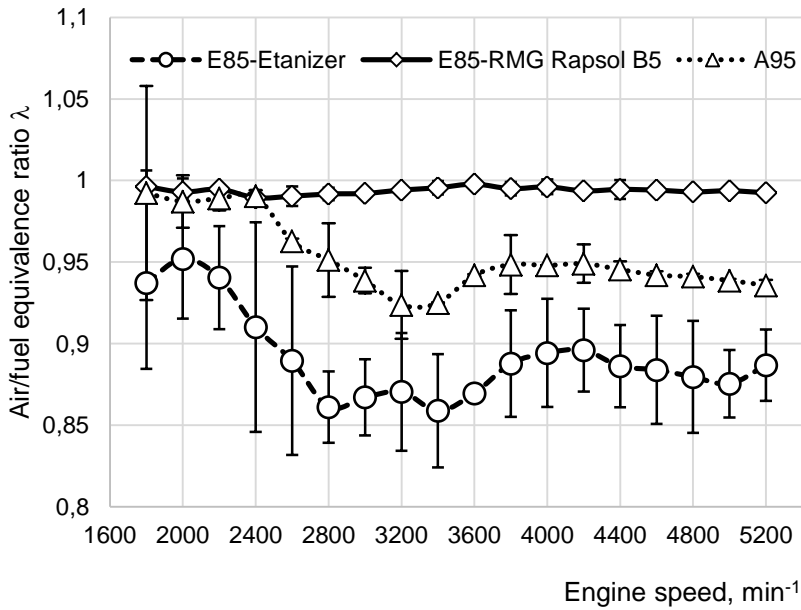

Figure 8. Fuel and conversion kit influence on air-fuel equivalence ratio.

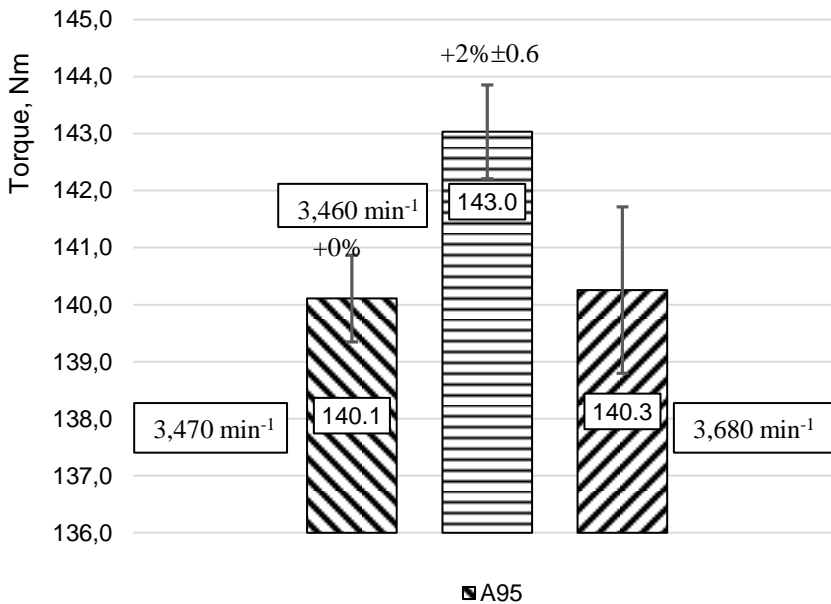

Figure 9. Engine maximum torque comparison depending on conversion kit.

Using conversion kit *Etanizer* and E85 fuel, the air/fuel mixture is over enriched. Air/fuel equivalence ratio curve follows gasoline pattern, but reaches a value between 0.95 and 0.85. Conversion kit *Etanizer* generates an additional injector control signal in proportion to the signal supplied by the ECU. Feedback is not used to control and

correct the amount of enrichment. Additionally excess enrichment measurement can be caused by erratic engine operation, and as result fuel burn is incomplete.

A different situation is observed during engine operation with conversion kit *RMG Rapsol B5-STANDARD*. Regardless that in selected test conditions the engine is operating in open loop mode, the conversion kit control module receives information from the oxygen sensor and corrects the duration of injector control. It is clearly shown in Fig. 8. Air/fuel equivalence ratio is close to stoichiometric in all engine speed ranges. According to Jiang et al. (2009), stronger charge cooling effect of E85 fuel reduces the exhaust temperature and thus allows stoichiometric combustion over a wider range of engine speeds. Such composition of fuel mixture is acceptable when the engine is working on E85 fuel.

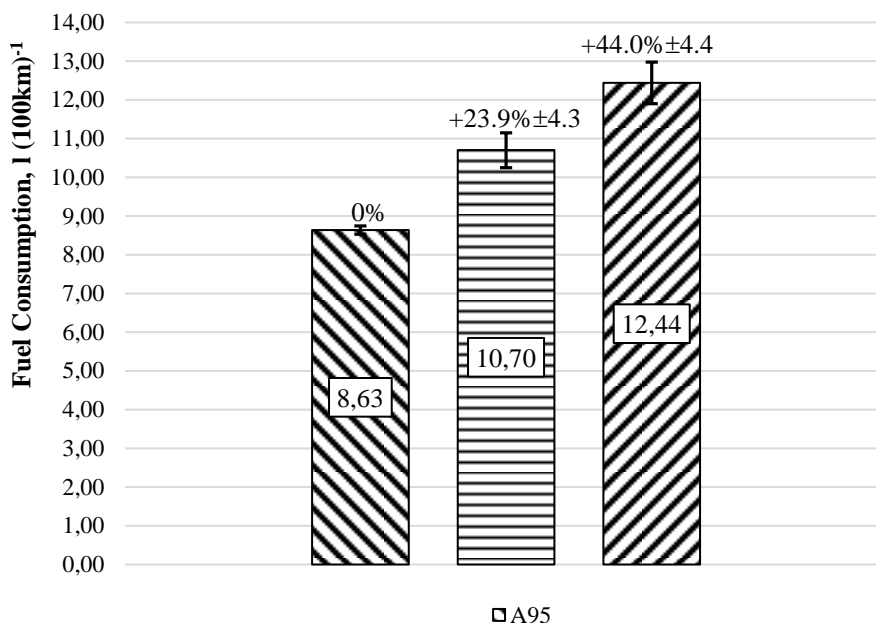

Figure 10. Fuel and conversion kit influence on average fuel consumption during IM-240 test.

The findings demonstrate that a different basis of correction of fuel mixture has an effect on average fuel consumption. Data collected during driving test cycle IM-240, shows that fuel consumption is 23.9% larger using conversion kit *RMG Rapsol B5-STANDARD* and E85 fuel, comparing with operation of an unmodified engine on gasoline. Results are presented in Fig. 10. Increase of fuel consumption is caused by a different stoichiometric ratio and heating values of tested fuels.

Use of conversion kit *Etanizer* and E85 fuel, when compared with operation of an unmodified engine on gasoline, causes an increase of fuel consumption by 44.0%. Such excessive consumption characterises the ineffective use of fuel and the flawed operation of the engine. Exploitation of the automobile in such conditions can affect driving experience and lead to premature failure of engine components.

CONCLUSIONS

1. Conversion kit *Etanizer* provides enrichment of air/fuel mixture by generating additional injector opening control impulse, and engine power and torque is decreased in engine speed range from $\sim 2000 \text{ min}^{-1}$ to $\sim 3600 \text{ min}^{-1}$.

2. Conversion kit *RMG Rapsol B5-STANDARD* manages enrichment of air/fuel mixture by prolonging original injector opening control signal, and value of maximal torque is increased by 2%.

3. Using conversion kit *Etanizer*, air/fuel mixture is over enriched ($\lambda \sim 0.95 - 0.85$), while *RMG Rapsol B5-STANDARD* maintains air/fuel equivalence ratio close stoichiometric in all engine speed range.

4. Average fuel consumption in driving test cycle IM-240 is by 23.9% larger using conversion kit *RMG Rapsol B5-STANDARD* and E85 fuel, and by 44.0% larger using conversion kit *Etanizer* and E85 fuel, comparing with operation of unmodified engine on gasoline.

5. Conversion kit *RMG Rapsol B5-STANDARD* can be used as one of the components to convert automobile for use with E85 fuel.

ACKNOWLEDGMENTS. Publication and dissemination of research results has been made possible due to the funding of the ERAF Project ‘Promotion of scientific activities of LLU’, Contract Nr. 2010/0198/2DP/2.1.1.2.0/10/APIA/VIAA/020.

REFERENCES

- Directive 2009/28/EC of the European Parliament and of the Council, <http://eur-lex.europa.eu/LexUriServ/LexUriServ.do?uri=Oj:L:2009:140:0016:0062:en:PDF> (accessed 10.01.2013)
- Fuel conversion adapter Whitelighting, http://www.whitelighting.net/e85_store.html (accessed 10.01.2013)
- Fuel conversion adapter Ecofuelbox, <http://www.ecofuelbox.com/en/4-Cylinders-Ethanol-e85-Kit.html> (accessed 10.01.2013)
- Fuel conversion adapter Flexfuelus, <http://www.flexfuelus.com> (accessed 10.01.2013)
- Mistris, J., Birzietis, G. 2011. Perspective most widespread used vehicle fuel systems in Latvia, **In: Proceedings of 10th International Scientific Conference Engineering for Rural Development**, Latvia University of Agriculture, Jelgava, pp. 282–287.
- Jiang, L., Yilmaz, H., Christie, M., Ahn, K., Strfanopoulou, A. 2010 *Optimally Controlled Flexible Fuel Vehicle*, **In: Proceedings of 10th Stuttgart International Symposium, FKFS**, Stuttgart, pp. 1–15.
- Pirs, V., Malnicenko, V. 2010, V. Bioethanol Gasoline Fuel Blends Effect of SI Engine Operating Parameters, *Research papers of Lithuanian University of Agriculture*, **42 (2)**, pp. 115–126.
- Pourkhesalian, A.M., Shamekhi, A.H., Salimi, F. 2010. ‘Alternative fuel and gasoline in an SI engine: A comparative study of performance and emissions characteristics’, *Fuel*, **89 (5)**, pp. 1056–1063.